

The World's Leading Venturi Manufacturer and Leading Flow Engineer

Introduce the First New Proven Venturi Meter Design in 30 Years

The AMITY design objective was to have meters perform to the ASME PTC throat tap nozzle design (ASME-PTC-6, 1996). This meter is used for high accuracy performance tests in nuclear power plants. The success of this design is based on established metering principles. The AMITY meters have met these criteria while competitive meters have not produced data to support this performance level.

The AMITY throat metering section replicates the PTC-6 design. Test data confirms that the AMITY "S" and "T" designs have similar PTC-6 published calibration results, leading to the following conclusions,

- The history of calibration tests on PTC-6 nozzles can be applied to the Amity designs.
- Tests to date are within $\pm 0.15\%$ of expected performance for a single tapping.
- Extrapolation easily meets The PTC-6 requirements (ASME PTC-6A, 2000).
- An un-calibrated accuracy of $\pm 0.50\%$ is supported, with a future potential of $\pm 0.25\%$.

DESIGN OBJECTIVES

- Size and Compute dimensions with The FLOW CONSULTANT (2010) PC software.
- Compute and manufacture critical dimensions based on pressure and temperature corrections presented in Miller *Flow Measurement Engineering Handbook* (GENERIC SOLUTION (pg 9.107-9.117 3rd Edition))
- Minimize overall pressure loss using the Gibson method to design the recovery cone
- Streamline the flow through all sections to minimize overshoot and overall pressure loss
- Easily and timely add user inputs and requirements to module.
- Develop and check AMITY module equations using Math Cad and the CFD AMITY program

Amity Flow Venturies
R.W. Miller PhD, PE

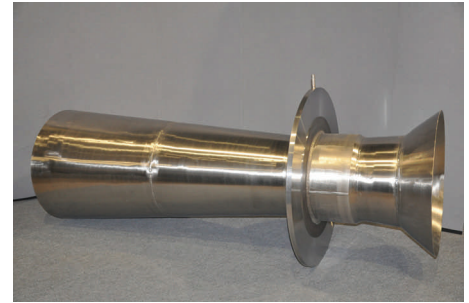

Amity's 36" AVM-T-1 Insert Style Venturi Meter

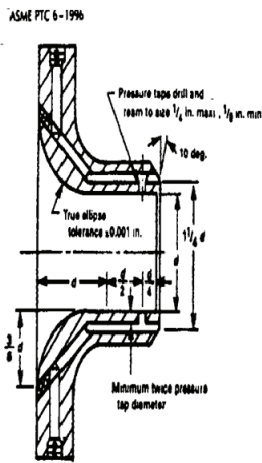

Figure 1 ASME PTC-6 Nozzle

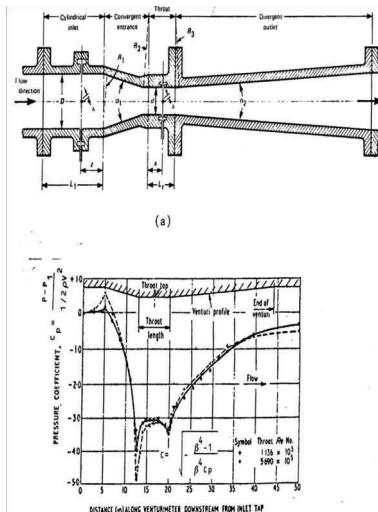

Figure 2 ASME Venturi Pressure Profile

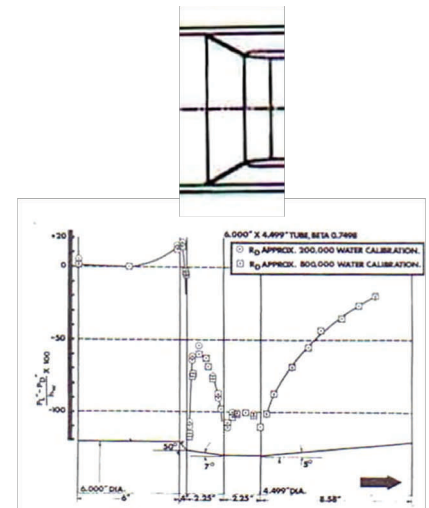

Figure 3 Halmi (1973) Pressure Profile

The ASME PTC-6 nozzle is illustrated in Figure 1. The elliptical entrance section pressure profile is essentially a smooth favorable pressure gradient (Rivas, R.A. and Shapiro, 1954) as it enters the throat. The pressure profile and geometry for the ASME Venturi is shown in Fig. 2 and that of the dual entrance cone HALMI (1973) in Fig. 3. Note that the ASME Venturi and HALMI dual cone have a distinct pressure transition into the throat region; this has been eliminated in the AMITY design.

Amity Flow

P.O. Box 355
491 Old Swede Road
Douglassville, Pa 19518

Phone: 610-385-6075
Fax: 610-385-6079
www.amityflow.com



Serving the Flow Measurement Industry for Over 36 Years

In viewing a Nozzle-Venturi three distinct sections are noted

- The favorable pressure gradient entrance to the throat section.
- The cylindrical throat region.
- The adverse pressure gradient recovery cone region.

Each of these regions was designed using technical papers and a Computational Fluid Dynamic (CFD) program. A CFD analysis being used to determine optimum design criteria for the inlet section, throat (or metering section), and to confirm the Gibson (1961) recovery cone derivation.

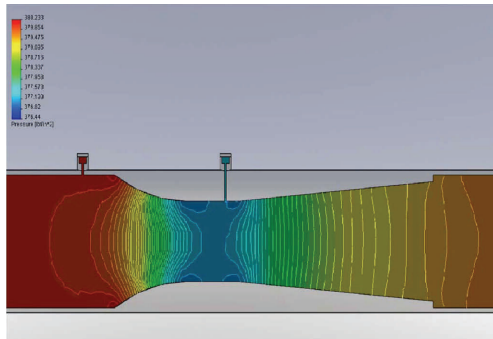

Figure 4 Amity S Design

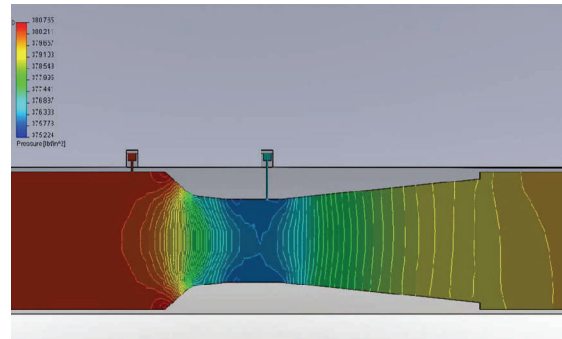

Figure 5 Amity T Design

Illustrated above are the resulting CFD's for the two basic AMITY designs.

S-Design A cylindrical radius is the inlet geometry. The entrance to the PTC-6 throat section is critical to insure boundary layer development length is in accordance with the PTC-6 theoretical extrapolation requirement (Keyser and Murdock, 1990). AMITY S-design use an inlet geometry of the Standardized Torodial Throat Nozzle (ASME/ANSI MFC-7M, 1990), extensive data and CFD studies show excellent entrance to the throat results for this geometry.

T-Design A Halmi double cone entrance with a unique cone angles and a throat entrance developed based on test results in Holland (Miller 1989), with confirming CFD studies.

Recovery cone geometry for both S and T is designed in accordance with the analysis developed by Gibson (1960) and results confirmed using CFD studies.

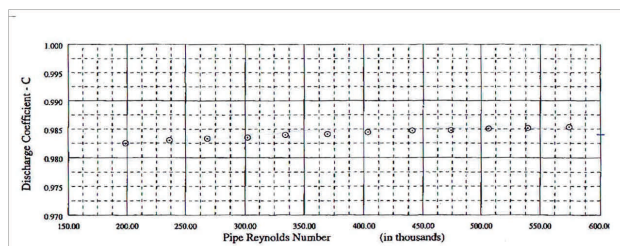

Figure 6 Typical Calibration Data

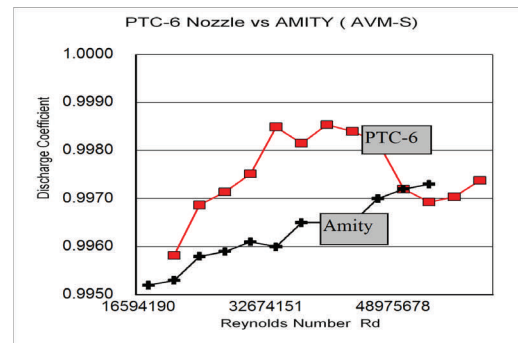

Figure 7 Comparison to PTC-6 Data

Calibration Shown in Figure 6 is a typical calibration curve and in Figure 7 a comparison of data to a PTC-6 nozzle calibration.

References

- ASME/ANSI MFC-7M Measurement of Gas Flow by Means of Critical Flow Venturi Nozzle, ASME NY 1987
- ASME PTC-6 Performance Test Code 6 on Steam Turbines, ASME, NY, 1996
- ASME PTC-6A Steam Turbines (Performance Test Code) Appendix Section 5, ASME. 2000
- The FLOW CONSULTANT, PC Software for differential producers and linear flowmeters, R.W.Miller & Associates, Inc. 2010
- Gibson, A.H., Hydraulics and It's Applications, Constable & Company, London England 1961
- Hall, G.W. Application of Boundary Layer Theory to Explain some Nozzle and Venturi Peculiarities Trans. IME, London Vol. 173 No.36 1959
- Halmi, D Metering Performance Investigation and Substantiation of the "Universal Venturi Tube" (U.V.T) ASME Paper 73-WA/FM-3 ASME 1973
- Keyser, D.R., Murdock, J.W. and Theoretical Basis for Extrapolation of Calibration Data of PTC-6 Throat Tap Nozzles, Jrl Pwr, Paper 90-JPGC-PTC28-4, 1990
- Miller, R.W., Test Results on a 36 inch Venturi, R.W.Miller unpublished, 1996
- Miller, R.W. Flow Measurement Engineering Handbook McGraw Hill, 1997
- Rivas, R.A. and Shapiro, A.H On the Theory of Discharge Coefficients for Rounded-Entrance Flowmeters and Venturis, ASME Paper 54-A-98, 1954